



Wood that lasts

Stock catalogue 2022



DEAR CUSTOMER,

We are glad to present to you our new Imprest catalogue for season 2022. The catalogue includes an overview of our products, production and quality as well as highlights the best-selling items that we are stocking for the next season. **Machine rounded posts and poles** fill the majority of the following pages as this product group forms the largest share of options for marking and delimiting territory and bringing order to the landscape. We also provide different solutions in the **gardening** and **hunting products** sections.

All the products are made from the highest quality Nordic raw materials. We sort the raw logs into 120 log pocket sizes which in further combinations enables truly flexible production of more than 1250 different end products in a year. The product selection includes the diameter range from 30mm to 200mm and lengths from 0,6m up to 6m, which enables to fulfil most customers requirements.

In order to give longer durability for the wood, we work in cooperation with Rütgers Organics GmbH and use their treatment chemical impralit®-KDS to support our customers with a **warranty of 25 years for Premium Range Postsaver and 15 years for Premium Range products**, both green and brown colours. Grey treatment colour can be used for products in hazard class 3.

Third parties auditing are an essential part of a modern and responsible company and are carried out on a regular basis in our production so we are certain of the highest quality of our processes and products. We are a **member of WPA** (Wood Preservation Association) in United Kingdom and our Premium Range machine rounded and pressure treated products are certified meeting their requirements of the WPA Benchmark Quality Scheme granting validity to carry the "Benchmark" logo. In Sweden we have been granted the **NTR certificate for NTR A and NTR AB** preservation classes confirming that our company is entitled to impregnate sawn and round wood with the chemical impralit®-KDS according to the requirements of the NTR (Nordic Wood Preservation Council).

As a firm that is constantly developing, we put great emphasis on environmentally friendly thinking. Since 2004 our enterprise has been **FSC®-certified** and so we are doing our share for sustainable forestry. Products made from FSC®-timber have been marked with FSC® logo in the product catalogue.

Imprest's mission is to ensure **longer-lasting wood solutions with quicker delivery**. This is enabled by our strong company structure, large base of quality raw materials, flexibility in production & best machinery, integrated computer system and professional representatives & distributors.

95% of our production is exported worldwide. **We have 6 subsidiaries in Europe** – in United Kingdom, Germany, France, Sweden, Norway and resellers in almost every European country. This guarantees even more efficiency in the company's sales and customer service processes.

You will find the range of childrens playgrounds, swings and sandpits alongside with the childrens play houses, garden timber or wide range of garden houses in our **Palmako catalogue**. If you wish to receive one of these catalogues, please contact our sales team who will be happy to help.

We appreciate your **feedback** regarding our products and services and are keen to know how you have used our products. Please share your ideas, proposals and photos with us by sending an e-mail to imprest@palmako.ee.

We wish you a pleasant browsing and a successful new season!
Your team at Imprest by Palmako

PRODUCT INDEX

IMPREST QUALITY AND PRODUCTION

3-6

ROUND FENCING

7-24

PREMIUM RANGE

8	Postsaver Protected Posts
11	Machine Rounded Bollards
13	Machine Rounded Posts
15	Machine Rounded Poles

STANDARD RANGE

17	Machine Rounded Posts
19	Machine Rounded Poles
20	Half Round Pales
21	Machine Rounded Mini Sleepers
22	Drilled Posts
24	Post Installation Guide

GARDENING

25-30

26	Vertical Fence Elements
27	Expandable Fence Elements
28	Log Roll
29	Solid-Log Edging
30	Vegetable Bed

HUNTING

31-33

32	Hunting Tower Eira
33	Hunting Tower Elenor 2

IMPREST – WOOD THAT LASTS

As a brand, Imprest places value on permanence. It knows that there's a place in the world for simple, lasting things that withstand complicated times and turbulent changes. Things where the developers don't have a single-minded goal of landing a profit in the shortest possible time.

Imprest believes that if more things in the world around us were handed down from generation to generation, we'd be happier and it might be easier for us to understand the passage of time and nature around us.

Imprest wants simple truths to last and to guide our everyday life. Core values should not fade away.

In Imprest's common-sense world, a fence is still a fence, a post is still a post – that's the way it's been since time immemorial, and that's the way it will always be. It is, rather than merely appearing to be.



QUALITY AND PRODUCTION

TIMBER QUALITY

We use for our products the finest Nordic spruce (Picea Abies) and pine (Pinus Sylvestris) originating from Estonian forests. Due to hard climate conditions the timber has grown slowly and therefore the strength and durability of the wood is much better compared to faster grown southern timber. Together with high quality pressure treatment the posts will last much longer!

MACHINING QUALITY

Before production each log is studied carefully — once in the forest by the harvest operator and once on our sorting line. A final check is done right before the packing of the final product. This thorough control ensures that all that goes into the pack is exactly as agreed with our customers.

Imprest has divided its poles into 4 quality classes to choose:

- Playground grade
- Landscaping grade
- Fencing grade
- Agricultural grade

PACKING QUALITY

Imprest packing has always been noted as one of the best! As all packs are perfectly square, they are easy to handle and store. The secure shape of the packs makes it possible to keep nice and clean stock where everything is in place and easily found. The packs have been constructed specifically so

that they keep their shape when opened. Therefore the round poles do not “escape” as soon as the belts are opened.

We are offering 3 different packing systems for machine rounded posts and poles:

- Standard System — Pack with 2 sticks
- Drying System — Pack with sticks after each layer of posts
- DIY System — Pack with smaller bundles in it/as per customer request



STANDARD SYSTEM

Diameter (mm)	Pieces/pack Full rounds	Pieces/pack — Half rounds
30	622	-
35	372	-
40	741	1482
45	563	1176
50	431	862
60	298	596
70	203	406
75	203	406
80	150	300
85	150	300
90	105	210
100	105	210
110	95	190
120	60	120
125	60	120
140	46	92
150	46	92
160	33	66
175	28	56
180	27	54
195	23	46

DRYING SYSTEM

Diameter (mm)	Pieces/pack Full rounds	Pieces/pack — Half rounds
30	-	-
35	-	-
40	513	-
45	408	-
50	336	672
60	238	476
70	180	360
75	168	336
80	143	286
85	132	264
90	120	240
100	90	180
110	80	160
120	64	128
125	56	112
140	49	98
150	42	84
160	36	72
175	30	60
180	30	60
195	25	50

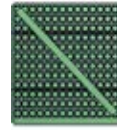
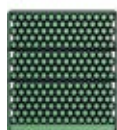



DRYING

For better absorption of treatment liquid timber needs drying. This process for Premium range products takes place in kiln drying chambers where spruce is dried to around 35% and pine below 28% moisture content. The process takes about a week but is essential for the final result.



MARKING WITH NAILS

Our Premium range posts are marked with nails for tracing — each post has a metal tag showing the Imprest logo and year of post's production. That way we can keep track of the lifetime and origin of the post. Using nails is the most effective method to do that since the metal survives weather damage and the origin of post can be traced for years.



INCISING

Incising is a process as a result of which incisions are cut into the surface layer of milled timber. Incising helps to facilitate an improved deeper impregnation of the timber which makes the treatment process more effective. The impregnation on

incised spruce results in at least 6 mm lateral penetration, which meets EU standards for treated timber products in ground contact. Without incising this cannot be achieved.



PRESSURE TREATMENT

Timber is vulnerable to attack from insects, damp and fungi and needs protection from all of these to extend its service life. In order to extend the service life of timber we treat our Premium range products with Impralit®-KDS wood preservative. This is a water-borne, chromium free wood preservative for the prevention of attack by insects (including termites), soft rot and fungal decay. It also offers temporary protection against blue stain and mould. The product has been on the market for over 20 years. Impralit®-KDS is only to be used for treating wood according to the requirements of use class 1, 2, 3 and 4 as specified in

EN 335. For wood under cover and in the open, above ground and in ground contact, e.g. poles, fencing, playgrounds, pergolas etc. The preservative penetrates deep into the wood with the help of vacuum and pressure. In this case a vacuum is initially generated in the cell cavities thereby evacuating the air inside them. The cavities are then filled with preservative solution which is forced into the wood under high pressure. For vacuum pressure impregnation we work with different processes depending on the type of wood, environment and end purpose. Imprest impregnation is also certified by NTR (Nordic Wood Preservation Council), and WPA (Wood Preservation Association).

PRESSURE TREATMENT AVAILABLE IN THREE COLOURS:

GNVPI - Green ("Park Green")



BNVPI - Brown ("Evening Brown")



GYVPI - Grey ("Vintage Grey")



PRESSURE TREATMENT

Species	Hazard class	Retention (analytical zone)	Analytical zone	Pre vacuum	Pressure	Final vacuum	Warranty
Spruce	HC3	6 kg/m ³	3 mm lateral	30 min	90-120 min	20 min	15 years
Spruce	HC4	15 kg/m ³	6 mm lateral	30 min	180 min-360 min		15 years
POSTSAVER	HC4	15 kg/m ³	6 mm lateral	30 min	180 min-360 min		25 years
Pine	HC3	6 kg/m ³	Full sapwood	30 min	45 min		15 years
Pine	HC4	15 kg/m ³	Full sapwood	30 min	90 min		15 years
Pine NTR AB	HC3	8 kg/m ³	Full sapwood	30-60 min	90-240 min		20 years
Pine NTR A	HC4	14 kg/m ³	Full sapwood	30-60 min	90-480 min	20 years	



ANALYZING RESULTS

The final step in Imprest’s production process is to measure and analyse whether all the production steps have been done correctly and meet the requirements of Imprest quality standards. Modern technologies, dedicated personnel and clear instructions throughout the process ensure that Imprest products really are premium in quality.



WARRANTY

We have carefully selected suppliers, professional personnel and good teamwork which all enables us to achieve high productivity and the right quality products. Therefore we can give a reliable warranty to our Premium range products. As our Premium range posts are marked with nails it is easy to trace their lifetime and follow the supply chain in order to meet the warranty conditions. More detailed warranty terms for Premium range products are available on request.



LOGISTICS

A combination of comprehensive stock of the best-selling items and regular transport solutions enable us to offer good lead times thus enabling the customers to react quicker to the needs of the market. The delivery time of stock items is usually 2 weeks from order with lorry to mainland Europe and via shipping to England and in case of good timing of days can even be shorter. We have loyal and reliable logistic partners who plan in advance with us and react to our needs quickly so even the more complicated



logistic solutions get arranged with ease and speed. We use ro-ro shipping line from Estonia to Harwich port with regular sailings 3-4 times a month and all the steps of the delivery process have been perfected throughout the years. In addition to the shipping line we can fully rely on the truck company in Estonia and the hauliers in the UK who are all dedicated to doing their part for a fast and efficient delivery service and keeping all parties informed of timings. The customer-oriented logistical solution is a benefit to all our customers and makes it easy to work with us.

WARRANTY TERMS FOR IMPREST PREMIUM RANGE POSTS & POLES

Imprest guarantees its products against failure from fungal decay, soft rot & insect attack. In case of premature failure caused by above named defects we will replace the product or cover the original cost of the product (the purchase value) whatever is more suitable at the time. This warranty does not cover the associated replacement costs of the products and is subject to the following:

PRODUCT

- Imprest Premium Range Posts & Poles.
- Dried and treated with Impralit®-KDS (RÜTGERS Organics GmbH).
- Incised prior to treatment in case of spruce.
- Marked with stamped nails stating Imprest logo (initials) and year of production.



USAGE

- Products are meant to be used in accordance with following treatment classes (EN335-1):
 - HC3 – outside but NOT in ground contacts,
 - HC4 – outside in ground contacts.
- Products must be installed into pure ground without breaking the treatment shield.
- Products cannot be mechanically altered once they are pressure treated – for example cutting, boring, drilling, pointing, chamfering, and splitting. Upon using cement for fixing the wood the installation must enable water to drain away.

- The guarantee will be void if products are wrongly installed or re-used after initial installation.
- When replacing the old and rotten products with Imprest Premium Range products it is vital that all of the decayed timber and infected soil is removed thoroughly.
- It is vital that the installation place is free of salty water.
- Sample of the “stamped nail” as well as a piece of failed products must be presented for inspection if required.
- Imprest has the right to inspect the claim on site.

CONCEPT

- “Failure” means damage caused either by fungal decay, soft rot or insect attack to such an extent that the product is no longer structurally fit for purpose.
- “Fungal decay” means wood destroying fungi that degenerates wood cell walls. It does not mean staining or mould fungi which are part of weathering of timber.
- “Insect attack” means wood digesting insects that attack and destroy timber structure.

Imprest treatment process & quality corresponds to EU standard EN351-1 and instructions received from chemical & material suppliers that allow us to expect our timber to last. Imprest is not taking responsibility in case of inefficiency of those.

More detailed warranty terms for Premium range products are available on request.





Round fencing

PREMIUM RANGE

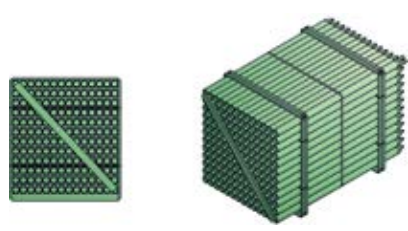

Packing according to Drying System.
(Preview of the Packaging System on page 2.)



Pointed & Chamfered (PC)

PREMIUM RANGE POSTSAVER PROTECTED POSTS

DESCRIPTION

End processing: Pointed & Chamfered (PC)
Surface: Incised
Treatment chemical: Impralit®-KDS; (colour: green/brown)
Treatment method: Vacuum-pressure-vacuum
Treatment class: HC4; Pre-dried below 35% of moisture content
Treatment standard: EN351-1 (penetration ≥ 6 mm)
Postsaver: Double layer sleeve applied to the ground level point
Warranty: 25 years (ask for terms)

PACKING

1,15 m x 1,15 m x length of the post in meters
(sticks between each layer)

DELIVERY

Availability: Ex stock
Delivery time: 2-6 weeks
Minimum order: 1 pack as part of a full load



PREMIUM RANGE POSTSAVER PROTECTED POSTS

Species	Diameter (mm)	Length (m)	Processing	Treatment	Split yes/no	Pieces/ pack	Pieces/ m ³	Product code	Stock product (Yes/No)
Spruce	75	1,80	PC	GNVPIH4	No	168	126	FP075180-1TFK3-B	YES
Spruce	75	2,40	PC	GNVPIH4	No	168	94	FP075240-1TFK3-B	YES
Spruce	85	1,80	PC	GNVPIH4	No	132	98	FP085180-1TFK3-B	YES
Spruce	85	2,40	PC	GNVPIH4	No	132	73	FP085240-1TFK3-B	YES
Spruce	100	1,80	PC	GNVPIH4	No	90	71	FP100180-1TFK3-B	YES
Spruce	100	2,40	PC	GNVPIH4	No	90	53	FP100240-1TFK3-B	YES
Pine	140	2,40	PC	GNVPIH4	No	49	27	FP140240-1TFM3-B	YES



Premium range Postsaver protected posts

NB! Imprest stock contains other products that are not listed here and we can manufacture also to orders. If you cannot find a product that suits your needs, please do not hesitate to send us your enquiries!



POSTSAVER®

Doubling The Life Of Your Fencing

EMBEDMENT OF POSTSAVER POSTS

X (post length) (mm)	Y (ground line) (mm)
1200	400 ± 20
1650	550 ± 20
1800	600 ± 20
2100	700 ± 20
2400	800 ± 20

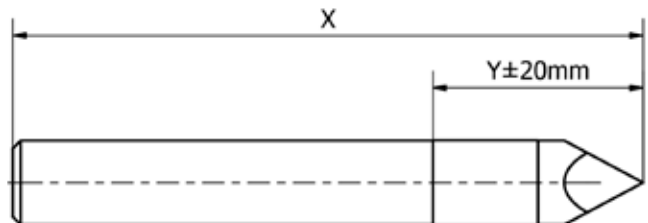

POSTSAVER® — CLEAN AND EASY WAY TO PREVENT GROUND ROT

POSTSAVER keeps moisture out & prevents ground rot

The weakest point with fence posts is the point where it enters the ground (ground line section). Usually the posts rot through at ground level whilst the rest of the fence is still in perfectly good condition. Postsaver bitumen sleeves provide an effective solution to this problem. They create a tough dual layer barrier that keeps the moisture, oxygen and decaying organisms that are necessary for wood rot and decay, out of the post.

Easy to use & clean to handle

The Postsaver sleeve is simply placed over the ground line section of the fence post. The sleeve is then heated causing the liner to melt whilst the outer thermoplastic sleeve shrinks down tightly on to the post. Once cooled the liner forms a clean and watertight seal to the pole surface and also adheres the outer heavy duty thermoplastic sleeve to the

wood to form a tough, durable, long lasting barrier. Postsaver coated posts have to be inserted about 1/3 in the ground until the ground line which is marked on Postsaver sleeve as well (see the illustrative picture of embedment of the posts on top of page). Postsaver sleeves make conventional ground rot practically impossible giving assured long term performance and lowest long term fencing costs.

Postsaver sleeves are non-toxic

Postsaver keeps the preservative in the wood thus reducing contamination of the ground and the environment by wood preservatives but still maintaining its protective effect. Postsaver sleeves are non-toxic and by products of burning the sleeve at end of life are the same as wood: CO², ash and water.

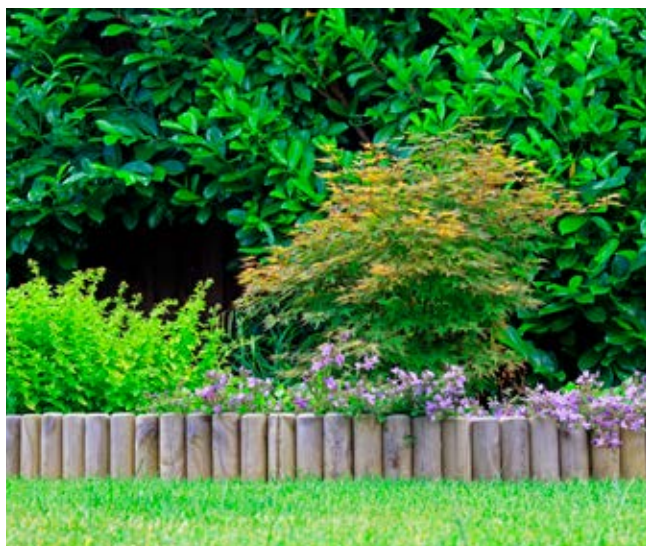

PREMIUM RANGE

Chamfered (C)

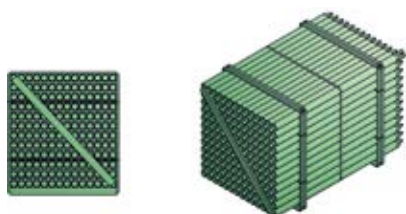

Packing according to Drying System.
(Preview of the Packaging System on page 2.)

PREMIUM RANGE MACHINE ROUNDED BOLLARDS

DESCRIPTION

End processing: Chamfered & Chamfered (CC)
Surface: Incised
Treatment chemical: Impralit®-KDS; (colour green/brown)
Treatment method: Vacuum-pressure-vacuum
Treatment class: HC4 (pre-dried below 35% of moisture content)
Treatment standard: EN351-1 (penetration ≥ 6 mm)
Warranty: 15 years (ask for terms)

PACKING

1,15 m x 1,15 m x length of the post in meters
(sticks between each layer)

DELIVERY

Availability: Available to order
Delivery time: 2-6 weeks
Minimum order: 1 pack as part of a full load

MEASURES & PACKAGING

Species	Diameter (mm)	Length (m)	Processing	Treatment	Split yes/no	Pc/pack	Pc/m³	Product code	Stock product (Yes/No)
Spruce	100	0,60	CC	GNVPIH4	No	180	212	FP100060-1FFK2	NO
Spruce	100	0,90	CC	GNVPIH4	No	90	141	FP100090-1FFK2	NO
Spruce	100	1,20	CC	GNVPIH4	No	90	106	FP100120-1FFK2	NO

NB! Imprest stock contains other products that are not listed here and we can manufacture also to orders. If you cannot find a product that suits your needs, please do not hesitate to send us your enquiries!





PREMIUM RANGE



Pointed (P)

Chamfered (C)

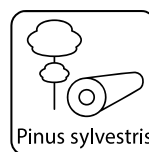
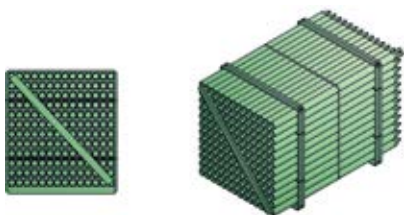

Packing according to Drying System.
(Preview of the Packaging System on page 2.)

PREMIUM RANGE MACHINE ROUNDED POSTS & POLES

DESCRIPTION

End processing: Pointed & Chamfered (PC); Chamfered & Chamfered (CC); Square (SQ)
Surface: Spruce surface incised
Treatment chemical: Impralit®-KDS; (colour: green/brown)
Treatment method: Vacuum-pressure-vacuum
Treatment class: HC4; Pre-dried below 35% (spruce) or 28% (pine) of moisture content
Treatment standard: EN351-1
Warranty: 15 years (ask for terms)

PACKING

1,15 m x 1,15 m x length of the post in meters
(sticks between each layer)

DELIVERY

Availability: Ex stock
Delivery time: 2-6 weeks
Minimum order: 1 pack as part of a full load

USAGE

Fence and gate posts, wire or rail fencing, electric fencing, playground structures, structural poles, ground works



PREMIUM RANGE MACHINE ROUNDED POSTS

Species	Diameter (mm)	Length (m)	Processing	Treatment	Split yes/no	Pc/pack	Pc/m ³	Product code	Stock product (Yes/No)
Spruce	60	1,50	PC	GNVPIH4	No	238	236	FP060150-1TFK3	YES
Spruce	60	1,80	PC	GNVPIH4	No	238	196	FP060180-1TFK3	YES
Pine	60	2,00	PC	GNVPIH4	No	238	177	FP060200-1TFM3	YES
Pine	60	2,50	PC	GNVPIH4	No	238	141	FP060250-1TFM3	YES
Spruce	75	1,80	PC	GNVPIH4	No	168	126	FP075180-1TFK3	YES
Spruce	75	2,40	PC	GNVPIH4	No	168	94	FP075240-1TFK3	YES
Pine	80	2,00	PC	GNVPIH4	No	143	99	FP080200-1TFM3	YES
Pine	80	2,50	PC	GNVPIH4	No	143	80	FP080250-1TFM3	YES
Pine	80	3,00	PC	GNVPIH4	No	143	66	FP080300-1TFM3	YES
Spruce	85	1,80	PC	GNVPIH4	No	132	98	FP085180-1TFK3	YES
Spruce	85	2,40	PC	GNVPIH4	No	132	73	FP085240-1TFK3	YES
Spruce	100	1,80	PC	GNVPIH4	No	90	71	FP100180-1TFK3	YES
Pine	100	2,00	PC	GNVPIH4	No	90	64	FP100200-1TFM3	YES
Spruce	100	2,40	PC	GNVPIH4	No	90	53	FP100240-1TFK3	YES
Pine	100	2,50	PC	GNVPIH4	No	90	51	FP100250-1TFM3	YES
Pine	140	2,40	PC	GNVPIH4	No	49	27	FP140240-1TFK3	YES
Pine	150	2,40	PC	GNVPIH4	No	42	24	FP150240-1TFM3	YES



Premium range machine rounded posts

NB! Imprest stock contains other products that are not listed here and we can manufacture also to orders. If you cannot find a product that suits your needs, please do not hesitate to send us your enquiries!

PREMIUM RANGE MACHINE ROUNDED POLES

Species	Diameter (mm)	Length (m)	Processing	Treatment	Split yes/no	Pc/pack	Pc/m ³	Product code	Stock product (Yes/No)
Pine	80	2,00	CC	GNVPIH4	No	143	99	FP080200-1FFM2	YES
Pine	80	2,50	CC	GNVPIH4	No	143	80	FP080250-1FFM2	YES
Pine	80	3,00	CC	GNVPIH4	No	143	66	FP080300-1FFM2	YES
Pine	80	4,00	CC	GNVPIH4	No	143	50	FP080400-1FFM3	YES
Pine	100	2,00	CC	GNVPIH4	No	90	64	FP100200-1FFM2	YES
Pine	100	3,00	CC	GNVPIH4	No	90	42	FP100300-1FFM2	YES
Pine	100	4,00	CC	GNVPIH4	No	90	32	FP100400-1FFM2	YES



Premium range machine rounded poles

NB! Imprest stock contains other products that are not listed here and we can manufacture also to orders. If you cannot find a product that suits your needs, please do not hesitate to send us your enquiries!

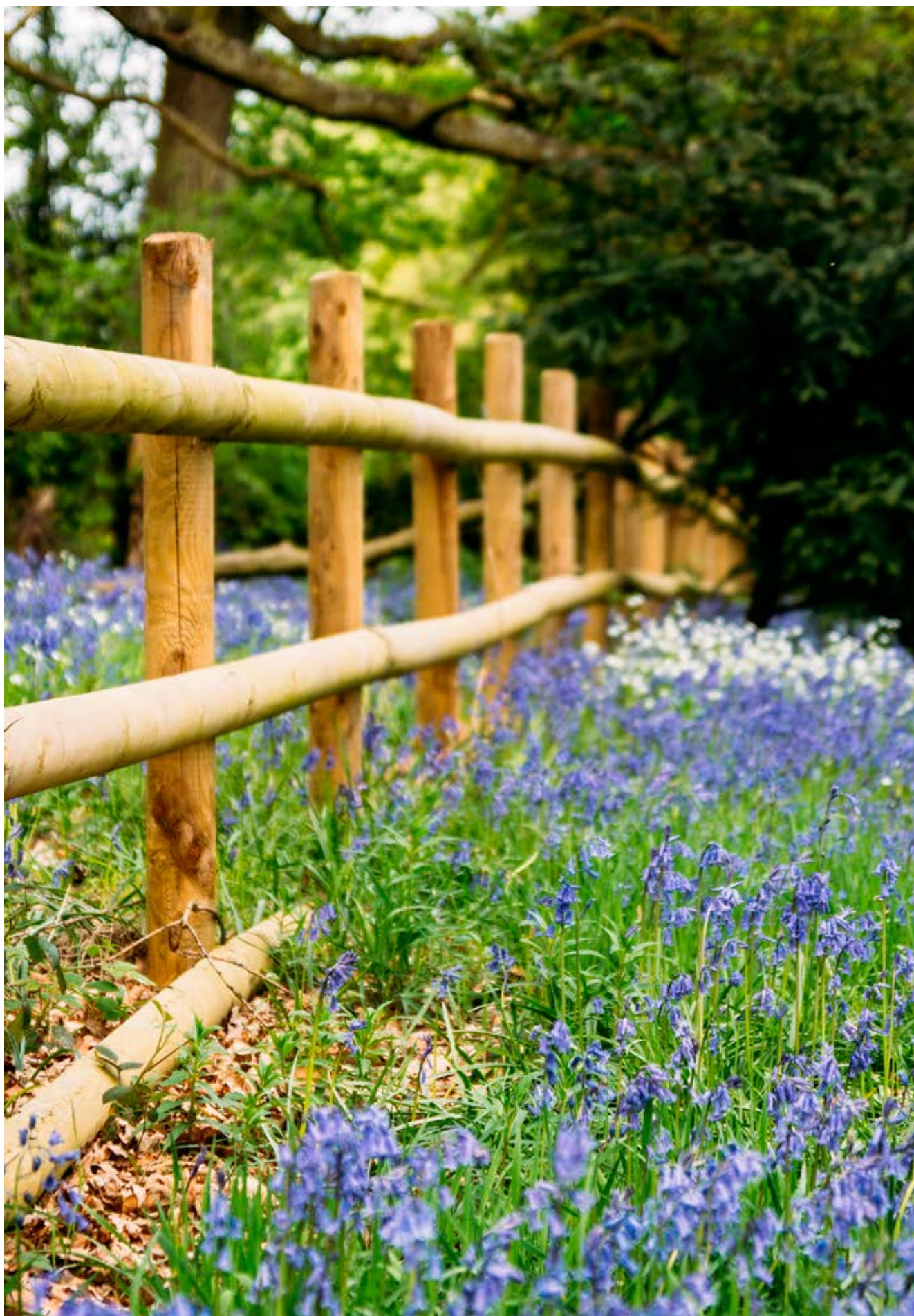

STANDARD RANGE



Pointed (P)



Chamfered (C)



Square cut (SQ)



Option: split

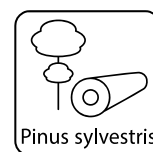
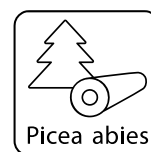
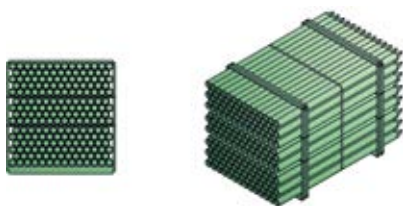

Packing according to Standard System.
(Preview of the Packaging System on page 2.)

STANDARD RANGE MACHINE ROUNDED POSTS & POLES

DESCRIPTION

End processing: Pointed & Chamfered (PC);
Chamfered & Chamfered (CC); Square & Square (SQ)
Treatment chemical: Impralit®-KDS
Treatment method: Vacuum-pressure-vacuum (colour:
green/brown/grey)
Expected service life: 5-10 years

PACKING

1,15 m x 1,15 m x length of the post in meters

DELIVERY

Availability: Ex stock
Delivery time: 2-6 weeks
Minimum order: 1 pack as part of a full load

USAGE

Ground works, tree stakes, fencing



STANDARD RANGE MACHINE ROUNDED POSTS

Species	Diameter (mm)	Length (m)	Processing	Treatment	Split yes/no	Pc/pack	Pc/m ³	Product code	Stock product (Yes/No)
Spruce	35	1,50	PC	GNVPI	No	372	693	FP035150-1TFK5	YES
Spruce	50	1,50	PC	GNVPI	No	431	340	FP050150-1TFK3	YES
Pine	60	2,50	PC	GNVPI	No	298	141	FP060250-1TFM3	YES
Spruce	75	1,65	PC	GNVPI	No	203	137	FP075165-1TFK3	YES
Spruce	75	1,80	PC	GNVPI	No	203	126	FP075180-1TFK3	YES
Pine	80	2,50	PC	GNVPI	No	150	80	FP080250-1TFM3	YES
Pine	80	3,00	PC	GNVPI	No	150	66	FP080300-1TFM3	YES
Spruce	100	1,80	PC	GNVPI	No	105	71	FP100180-1TFK3	YES
Pine	100	3,00	PC	GNVPI	No	105	42	FP100300-1TFM3	YES
Pine	120	2,50	PC	GNVPI	No	64	35	FP120250-1TFM3	YES



NB! Imprest stock contains other products that are not listed here and we can manufacture also to orders. If you cannot find a product that suits your needs, please do not hesitate to send us your enquiries!

STANDARD RANGE MACHINE ROUNDED POLES

Species	Diameter (mm)	Length (m)	Processing	Treatment	Split yes/no	Pc/pack	Pc/m ³	Product code	Stock product (Yes/No)
Pine	80	2,50	CC	GNVPI	No	150	80	FP080250-1FFM2	YES
Pine	80	3,00	CC	GNVPI	No	150	66	FP080300-1FFM2	YES
Pine	80	4,00	CC	GNVPI	No	150	50	FP080400-1FFM2	YES
Spruce	85	2,50	CC	GNVPI	Yes	300	70	FP085250-2FFK3	YES
Spruce	85	3,00	CC	GNVPI	Yes	300	118	FP085300-2FFK3	YES
Spruce	85	3,66	SQ	GNVPI	Yes	300	96	FP085366-2K3	YES
Pine	100	2,00	CC	GNVPI	No	105	64	FP100200-1FFM2	YES
Pine	100	2,50	CC	GNVPI	No	105	51	FP100250-1FFM2	YES
Pine	100	3,00	CC	GNVPI	No	105	42	FP100300-1FFM2	YES
Spruce	100	3,66	SQ	GNVPI	Yes	210	70	FP100366-2K3	YES
Spruce	100	3,66	SQ	GNVPI	No	105	35	FP100366-1K3	YES
Pine	100	4,00	CC	GNVPI	No	105	32	FP100400-1FFM2	YES
Pine	100	5,00	CC	GNVPI	No	90	25	FP100500-1FFM3	YES
Pine	120	3,00	CC	GNVPI	No	60	29	FP120300-1FFM2	YES
Pine	120	4,00	CC	GNVPI	No	60	22	FP120400-1FFM2	YES



NB! Imprest stock contains other products that are not listed here and we can manufacture also to orders. If you cannot find a product that suits your needs, please do not hesitate to send us your enquiries!



Half round pales — chamfered top (C0)

STANDARD RANGE HALF ROUND PALES — CHAMFERED TOP

Species	Diameter (mm)	Length (m)	Processing	Treatment	Split yes/no	Pc/pack	Pc/m ³	Product code	Stock product (Yes/No)
Spruce	60	1,15	C0	GNVPI	Yes	596	615	FP060115-2FK3	YES
Spruce	60	1,45	C0	GNVPI	Yes	596	488	FP060145-2FK3	YES

NB! Imprest stock contains other products that are not listed here and we can manufacture also to orders. If you cannot find a product that suits your needs, please do not hesitate to send us your enquiries!

STANDARD RANGE



Square cut (SQ)



Option: split



Mini sleepers packaging



STANDARD RANGE MACHINE ROUNDED MINI SLEEPERS

DESCRIPTION

End processing: Square & Square (SQ)

Treatment chemical: Impralit®-KDS

Treatment method: Vacuum-pressure-vacuum (colour: green/brown/grey)

Expected service life: 5-10 years

PACKING

1,15 m x 1,15 m x length of the post in meters

DELIVERY

Availability: Available to order

Delivery time: 2-6 weeks

Minimum order: 1 pack as part of a full load

MEASURES & PACKAGING

Species	Diameter (mm)	Length (m)	Processing	Treatment	Split yes/no	Pc/pack	Pc/m ³	Product code	Stock product (Yes/No)
Spruce	120	2,4	SQ	GNVPI	No	80	37	ML120240-1K3	NO
Spruce	120	2,4	SQ	GNVPI	Yes	160	74	ML120240-2K3	NO
Spruce	125	1,2	SQ	GNVPI	No	80	68	ML125120-1K3	NO
Spruce	125	1,8	SQ	GNVPI	No	80	45	ML125180-1K3	NO
Spruce	125	2,4	SQ	GNVPI	No	80	34	ML125240-1K3	NO
Spruce	140	2,4	SQ	GNVPI	No	28	27	ML140240-1K3	NO

NB! Imprest stock contains other products that are not listed here and we can manufacture also to orders. If you cannot find a product that suits your needs, please do not hesitate to send us your enquiries!



UK & IRELAND



EUROPE MAINLAND

STANDARD RANGE



Square (SQ); Chamfered (C); Pointed (P)



Preview of the Packaging System on page 2

STANDARD RANGE DRILLED POSTS

DESCRIPTION

End processing: Pointed & Chamfered (PC); Chamfered (C); Square (SQ)

Treatment chemical: Impralit®-KDS

Treatment method: Vacuum-pressure-vacuum (colour: green/brown/grey)

Treatment standard: EN351-1

PACKING

1,15 m x 1,15 m x length of the post in meters

DELIVERY

Availability: Available to order

Delivery time: 2-6 weeks

Minimum order: 1 pack as part of a full load

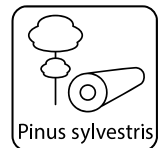

Also available in Premium quality!

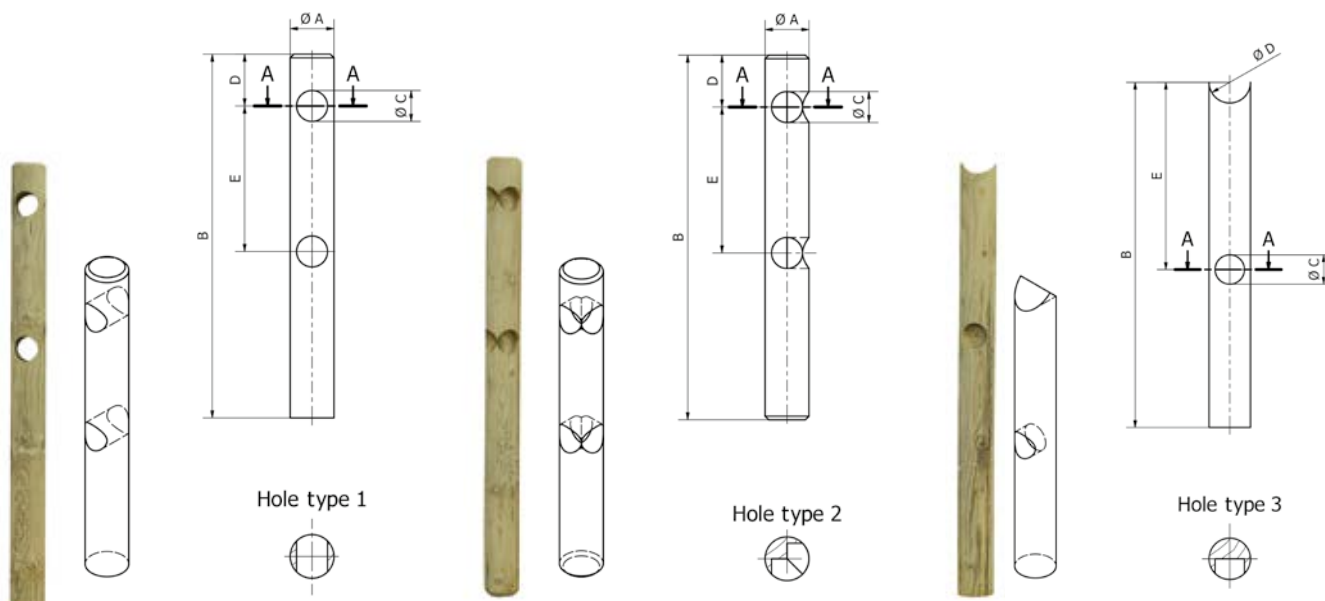

Type 1

Type 2

Type 3

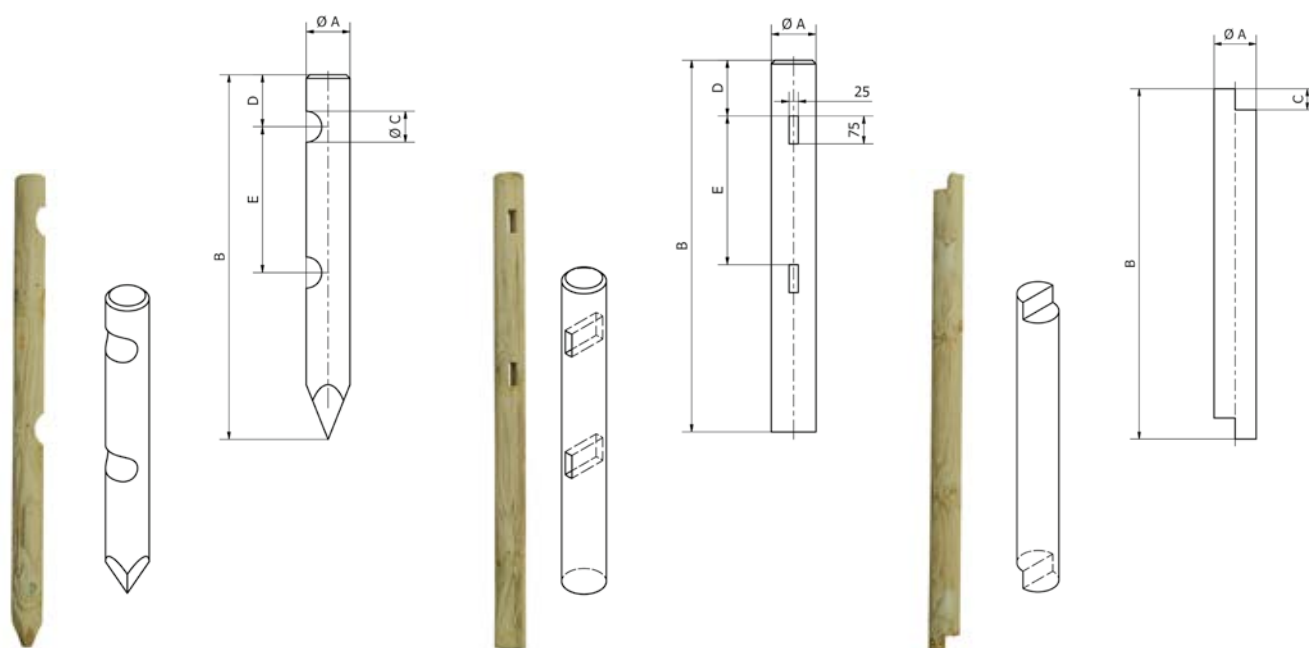

Type 4

Type 5

Type 6

STANDARD RANGE DRILLED POSTS — SAMPLE SIZES

Diameter (mm)	Length (m)	Pieces/pack
120	1,50	60
120	1,65	60
120	2,00	60

NB! Imprest stock contains other products that are not listed here and we can manufacture also to orders. If you cannot find a product that suits your needs, please do not hesitate to send us your enquiries!

GENERAL INSTRUCTIONS FOR POST INSTALLATION

NOTE: The type and design of a fence line should be commensurate with its intended use in practice and the expected service life.

Please contact our sales team to get more specific guidelines to specification for different types of fencing.

Timber posts should be treated to the appropriate specification to achieve the desired service life.

All timber posts should be treated to meet the preservative penetration and retention requirements. Particular consideration should be made to incising of refractory species where achieving the correct level of penetration can be difficult.

NOTE: Posts should not be pointed, cross cut or ripped after treatment. Such posts should be retreated.

Post Installation:

1. The size of the hole required for the post is dependent on the height and type of the fence.

2. Concrete could be used to fix timber posts into the ground in order to give them stability once set.

NOTE: Timber through its nature will however naturally shrink and swell with changes in ambient conditions.

3. Timber posts could be set in concrete (or soil) on top of a minimum 50 mm ballast/gravel bed as shown in Figure 2 (or Figure 1 when in soil) since this allows drainage to take place between the post and concrete (or soil).

NOTE: Ballast/gravel will assist in the final position of the post prior to adding concrete.

4. We recommend to insert the posts in the ground in about 1/3 of the post's full length.

NOTE: For Postsaver installation depth guidelines please turn to page 10.

5. Under no circumstances should posts be allowed to set on top of a concrete boot (Figure 4) since this prevents drainage and can lead to premature failure of the post under certain conditions.

6. Concrete is to be filled into 50 mm from the ground line and should be tampered as appropriate to remove residual air.

7. The uppermost 50 mm should be filled in with ballast/gravel to allow free drainage of moisture. This will also restrict vegetative growth at the base of the post and limit the need for the use of a mechanical strimmer which could damage the base of the post.

8. Alternative installation in concrete practice is advised in Figure 3.

Health & Safety:

A risk assessment of the work area should be made prior to the installation work being carried out and if necessary the appropriate PPE should be used at all times.

Care should be taken whether underground services (electrical cables, gas pipes, water etc.) exist in an area to be excavated and a Cable Avoidance Tool should be used wherever possible.

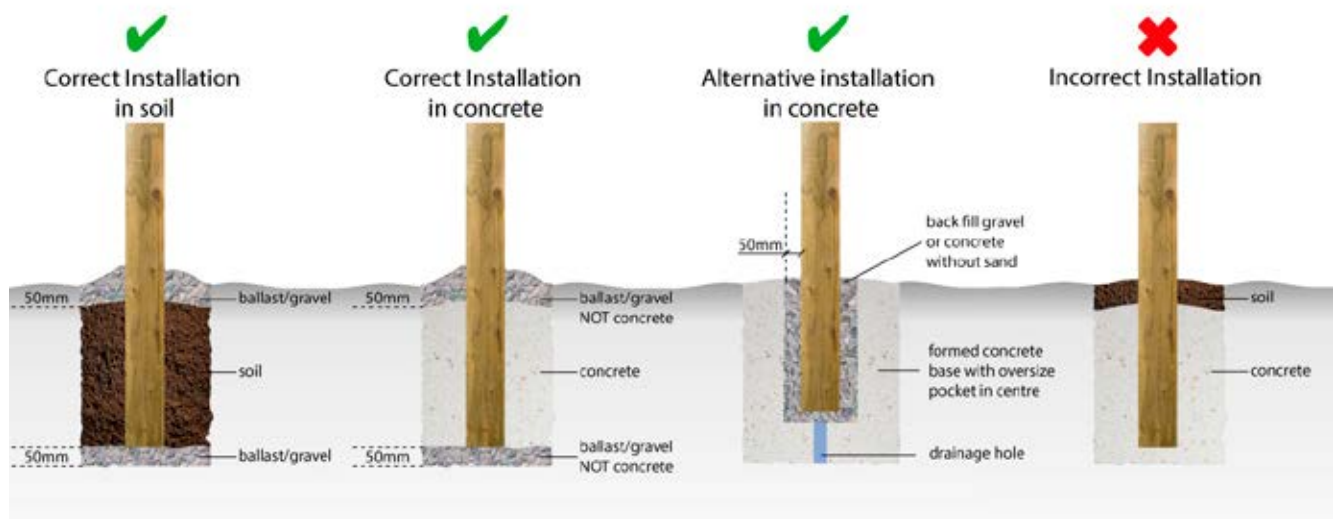

Figure 1

Figure 2

Figure 3

Figure 4



Gardening



VERTICAL FENCE ELEMENTS

DESCRIPTION

Pre-nailed fence elements
 60 mm half round pales with chamfered tops
 19 pales per fence element
 Element + one loose pale to cover the joints
 Two 85 mm half round rails
 Galvanized nails
 Pressure treated, green

ADDITIONS

75, 85 or 100 mm posts (page 9 or 14)
 140 or 150 mm gate posts (page 14)

DELIVERY

Orders shipped within 2-4 weeks
 Minimum order — 1 pack as part of a full load
 Available to order

MEASURES & PACKAGING

Product name	Diameter (mm)	Width (mm)	Height (mm)	Pc/pack	Pc/truck	Pack measures (mm)	Product code
Vertical fence element 1	60	2400	1150	24	480	2500 x 1300 x 1100	AE60-11502400
Vertical fence element 2	60	2400	1450	24	480	1550 x 1300 x 1100	AE60-14502400



EXPANDABLE FENCE ELEMENTS

DESCRIPTION

Pre-nailed fence elements
 60 mm half round pales with chamfered tops
 22 pales per fence element
 Galvanized nails
 Pressure treated, green

ADDITIONS

85 mm half round rails (page 19)
 85 or 100 mm posts (page 9 or 14)
 140 or 150 mm gate posts (page 14)

DELIVERY

Orders shipped within 2-4 weeks
 Minimum order — 1 pack as part of a full load
 Available to order

MEASURES & PACKAGING

Product name	Diameter (mm)	Width (mm)	Height (mm)	Pc/pack	Pc/truck	Pack measures (mm)	Product code
Expandable fence element 1	60	2500	1000	16	768	1200 x 1500 x 1100	AE60-10002500
Expandable fence element 2	60	2500	1200	16	640	1500 x 1500 x 1100	AE60-12002500



LOG ROLL

DESCRIPTION

End processing: Cut at angle and Square

Detail shape: Half round

Treatment: Pressure treated, green/brown

Fastened with galvanized wire and staples

DELIVERY

Orders shipped within 2-4 weeks

Minimum order — 1 pack as part of a full load

Available based on stock

Product name	Diameter (mm)	Width (mm)	Height (mm)	Treatment	Colour	Pc/pack	Pc/truck	Pack measures (mm)	Product code
Log Roll ø50/200/2000	50	2000	200	BNVPI	Brown	60	3960	1100 x 900 x 1180	AD50-2002000
Log Roll ø50/300/2000	50	2000	300	BNVPI	Brown	36	2376	1100 x 900 x 1100	AD50-3002000
Log Roll ø75/150/1800	75	1800	150	GNVPI	Green	72	3456	1250 x 1000 x 1060	AD75-1501800
Log Roll ø75/225/1800	75	1800	225	GNVPI	Green	48	2304	1200 x 1000 x 1000	AD75-2251800
Log Roll ø75/300/1800	75	1800	300	GNVPI	Green	36	1728	1200 x 1050 x 1050	AD75-3001800
Log Roll ø75/375/1800	75	1800	375	GNVPI	Green	36	1584	1250 x 1000 x 1300	AD75-3751800



SOLID-LOG EDGING

DESCRIPTION

End Processing: Chamfered and Square (C0)

Detail shape: Half round

Treatment: Pressure treated, green

Fastened with galvanized nails and slats

DELIVERY

Orders shipped within 2-4 weeks

Minimum order — 1 pack as part of a full load

Available based on stock

MEASURES & PACKAGING

Product name	Diameter (mm)	Width (mm)	Height (mm)	Treatment	Colour	Pc/pack	Pc/truck	Pack measures (mm)	Product code
Solid-log edging ø85/150/950	85	950	150	GNVPI	Green	80	3520	1120 x 1120 x 1120	AD85-150950
Solid-log edging ø85/225/950	85	950	225	GNVPI	Green	60	2640	1200 x 1000 x 980	AD85-225950
Solid-log edging ø85/300/950	85	950	300	GNVPI	Green	40	1760	1200 x 1000 x 980	AD85-300950



VEGETABLE BED

DESCRIPTION

100 mm half round material
Treated, green

DELIVERY

Orders shipped within 2-4 weeks
Minimum order — 1 pack as a part of full load
Available to order

MEASURES & PACKAGING

Product name	Product measures (mm)	Pieces / pack	Pieces / truck	Pack measures (mm)	Treatment	Product code
Vegetable bed	2400 x 1200 x 300	12	480	2400 x 1000 x 720	GNVPI	AD100-24001200



Hunting



EIRA

DESCRIPTION

Machine rounded material

Platform height: 1,57 m

Platform and bench material: 28 mm boards

4 stand beams: Ø 80 mm x 2,5 m

Unassembled ladder with 4 steps

Ø 80 mm split ladder steps and Ø 70mm split support details

Assembly kit with installation manual

Treated, green

DELIVERY

Orders shipped within 2-4 weeks

Minimum order — 1 pack as part of a full load

Available to order



MEASURES & PACKAGING

Product name	Product measures (mm)	Pieces / pack	Pieces / truck	Pack measures (mm)	Treatment	Product code
Hunting tower Eira	1300 x 1300 x 2500	4	270	2510 x 1200 x 490	GNVPI	MV80-1313



ELENOR 2

DESCRIPTION

Machine rounded material

Platform height: 2,0 m

Platform and bench material: 30 x 120 x 1400 mm

5 stand beams: Ø 100 mm x 3,0 m

Unassembled ladder with 5 steps

Ø 100 mm split ladder steps and support details

Assembly kit with installation manual

Treated, green

DELIVERY

Orders shipped within 2-4 weeks

Minimum order — 1 pack as part of a full load

Available from stock



MEASURES & PACKAGING

Product name	Product measures (mm)	Pieces / pack	Pieces / truck	Pack measures (mm)	Treatment	Product code
Hunting tower Elenor 2	1800 x 1800 x 3000	2	96	3000 x 1200 x 300	GNVPI	MV100-1818-1

IMPREST

by **Palmako**



www.imprest.ee

Copyright 2022 Palmako AS

All rights reserved.

Printing errors, colour errors, mistakes
and technical changes reserved.

Pictures are illustrative only.

Palmako AS
Head Office

Näituse 25, 50409 Tartu,
Estonia

Phone: +372 744 6538

Fax: +372 735 5544

E-mail: imprest@palmako.ee

Imprest by Palmako
Production

Ojaküla, Viru-Nigula vald
Lääne-Virumaa 44020,
Estonia

Phone: +372 329 5824

Fax: +372 329 5823